



Business Enterprise Monitor Solutions

FlexScan®



W O R K
B E T T E R



C H O O S E
E I Z O

EIZO Corporation

153 Shimokashiwano, Hakusan, Ishikawa 924-8566 Japan
Phone +81-76-277-6792 Fax+81-76-277-6793

www.eizoglobal.com

EIZO EcoView NET is a trademark, and ScreenManager Pro, FlexScan, and EIZO are registered trademarks of EIZO Corporation.
Specifications are subject to change without notice.

Copyright © 2015 EIZO Corporation. All rights reserved.
(140911c) Printed in Japan, 9, 2015, 4K

EIZO — The Visual Technology Specialist

Comprehensive Solutions

EIZO integrates hardware and software technologies with consulting, web hosting, and other services for customers in a wide range of fields.

Integrated Approach

With over 45 years of technical expertise, EIZO is dedicated to developing innovative and high quality visual display solutions.



R&D

To incorporate the latest technologies in our products, we follow a unique in-house research and development production model.



Printed Circuit Boards

We apply our in-house production model to the production of our own printed circuit boards (PCBs) that are used in each EIZO monitor — essential to providing comprehensive quality control.



Manufacturing

Our in-house manufacturing combines manual and automated operations to ensure high quality products are made as efficiently as possible.

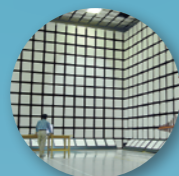

Quality Control

We use our own anechoic chambers to confirm that our products comply with international regulations covering electromagnetic interference (EMI) and susceptibility. We also conduct long-life testing where our monitors are kept powered on for thousands of hours and their image quality is checked regularly.



Customization

We offer extensive customization for select monitors to meet the diverse requirements of various markets, including mission-critical fields such as maritime and air traffic control.



Global Reach

EIZO products are highly regarded in many specialty fields throughout the world because of their accurate and stable image display. EIZO is based in Japan and is represented in over 80 countries by a network of group companies and exclusive distributors.

45+ years of expertise



FlexScan
Business Enterprise Monitor Solutions



ColorEdge
Color Management Monitor Solutions



FORIS
Gaming Monitors



RadiForce
Medical Monitor Solutions



CuratOR
Operating Room Solutions



DuraVision
Industrial Monitor Solutions



Raptor
Air Traffic Control Visual Display Solutions

Innovative Technology



Visibility-Enhancing Technology

EIZO's unique Smart Insight technology automatically detects dark areas of the screen and adjusts the brightness of each pixel while reproducing them with a realistic sense of depth.

Smart Resolution blur-reduction technology ensures noise is not accentuated while correcting blurred areas. It sharpens the foreground more strongly to maintain a real-world sense of focus.

Defog enhances images that are affected by fog, or other environment factors that cause the video to appear hazy or unclear

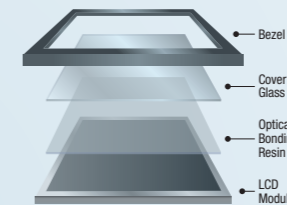

In-House Optical Bonding

EIZO has an in-house production line for optical bonding which allows the company to continue to meet the needs of professionals while ensuring each product maintains high quality standards.



Web Hosting

EIZO's Web Hosting QC solutions will free you from concern for initial investment and running cost. EIZO provides expert maintenance services and host the server for you.



IP Security Monitors

EIZO's IP solutions offer PC-less connection to multiple IP cameras for efficient video management in security and surveillance environments.

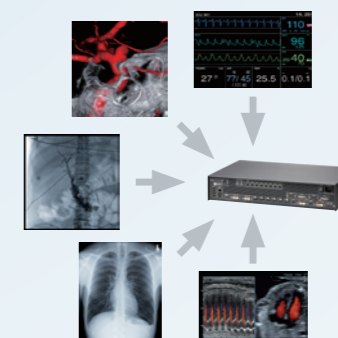

Video Management Solutions

EIZO's Large Monitor Managers gather various video inputs and display them on a large screen. Different layouts can be arranged according to user preference and work environment for a streamlined workflow.

Nice to look at. Better to use.



White



Black

FlexScan EV Series Ultra-Slim Monitors

FlexScan
EV2750

27" WQHD 2560x1440 5 Year Warranty

FlexScan
EV2455

24" WUXGA 1920x1200 5 Year Warranty

FlexScan
EV2450

23.8" FULL HD 1920x1080 5 Year Warranty



FUSION DESIGN

These monitors feature a new "Fusion" design that combines EIZO's own EcoView technologies for reduced power consumption and improved visual ergonomics inside an extremely compact cabinet.

World's Thinnest Bezels for Multi-Monitor Environments

The monitors feature ultra-slim bezels of just 1 mm on the sides and top with black borders of 5.7 mm or less on the LCD panel perimeter. The cabinet depth is a mere 48.5 mm for the FlexScan EV2750 and 47.9 mm for the FlexScan EV2455 and EV2450.

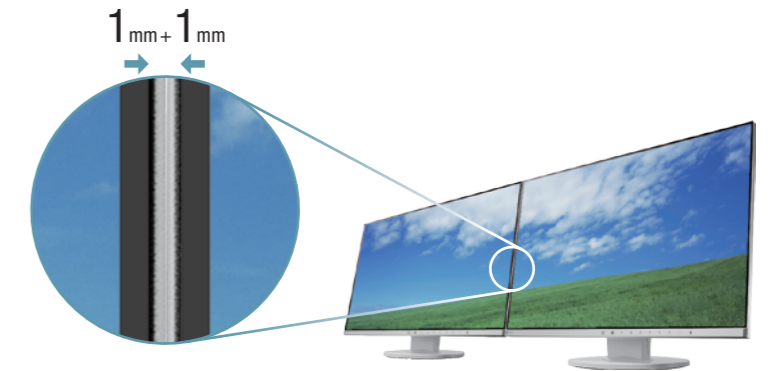

Best Positioning with Flexible Stand

adjustable height

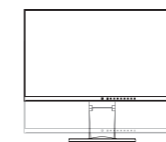

140*mm

* 155 mm with EV2750

rotation

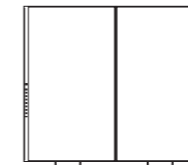

±90°

tilt

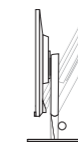

-5 to 35°

swivel

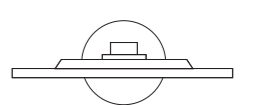

344°

Multiple Inputs

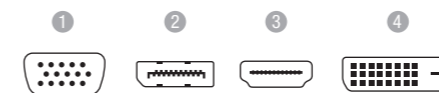

1 D-sub* 2 Displayport 3 HDMI 4 DVI-D

* D-Sub not included with EV2750

Audio and USB 3.0

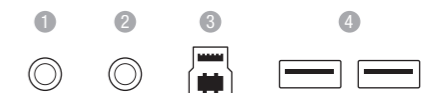

1 Audio Input 2 Headphones 3 USB Upstream 4 USB 3.0

Carrying Handle

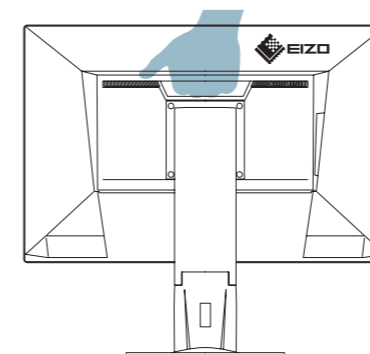

Cable Holder

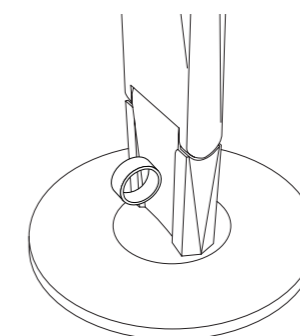

Speakers in Back

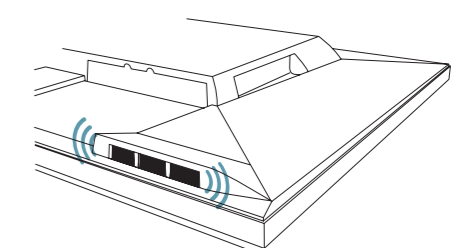

Say Goodbye to Tired Eyes



74% More Flicker-Free

Due to the way brightness is controlled on LED backlights, many people perceive flicker on their screen which causes eye fatigue. The FlexScan EV series makes flicker unperceivable without any drawbacks like compromising color stability. In a comparison test conducted by EIZO, the FlexScan EV2455 and EV2450 on average reduced flicker by more than 74% compared to LED-backlit monitors from other manufacturers.



Less Blue Light Reduces Eye Fatigue

In the visible light spectrum, blue light has wave lengths adjacent to ultraviolet light. Compared to the factory preset setting of 6,500 K of typical LCD monitors, Paper Mode is closer to the spectral distribution with long reddish wavelengths so it reduces the amount of blue light, a cause of eye fatigue, and helps prevent eyestrain when reading documents.



Clear View From All Angles

The monitors use an LED-backlit IPS (in-plane switching) LCD panel with 178° viewing angle that minimizes color shift and contrast changes when viewing the screen at an angle.

Auto Brightness Control

To prevent eye fatigue, a brightness sensor called Auto EcoView detects the changes in the ambient brightness that occurs throughout the day and automatically adjusts the screen to the ideal brightness level.

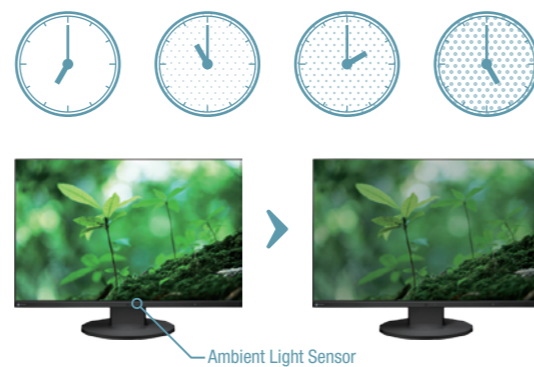

Adjustable to Less Than 1% of Maximum Brightness

In a dimly-lit work environment, a monitor with low brightness settings is more comfortable to use. With its LED backlight, the monitors are adjustable to 1 cd/m² which is less than 1% of the maximum.



Lower Your Costs

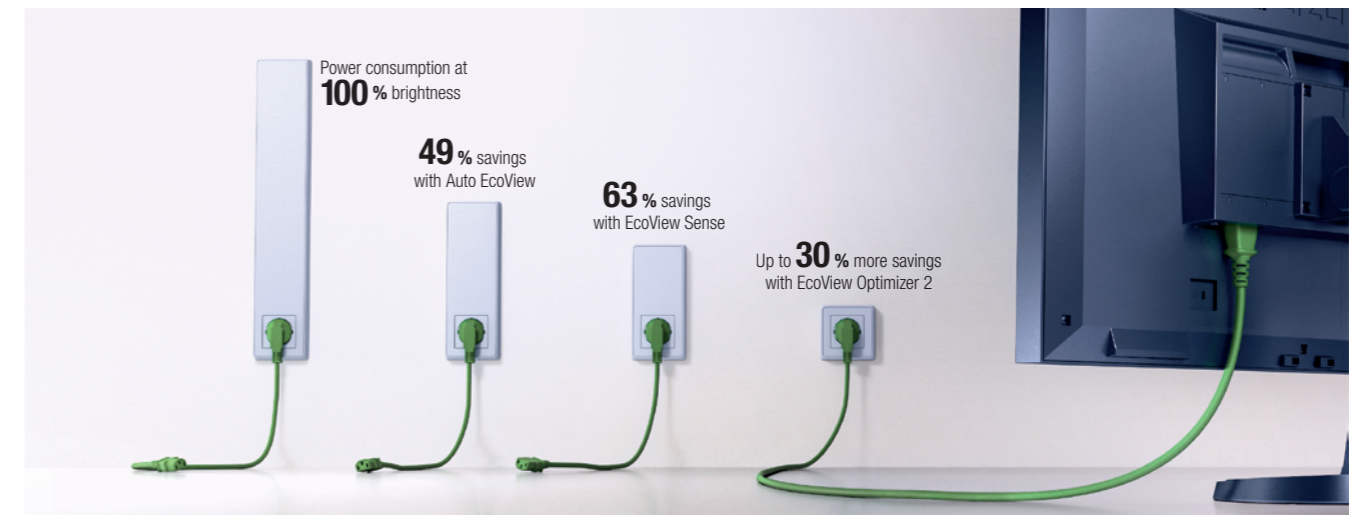

LED Backlights – Less Power, Longer Life

Compared to CCFL backlights, LED backlights last longer and consume less power. They are also mercury-free for minimal environmental impact.

Presence Sensor for Energy Savings

A presence sensor* called EcoView Sense prompts the monitor to switch to power save mode when you are absent and then power on again when you return. It even works in a multi-monitor setup so all monitors remain on when you're at your desk.

* Not included with EV2750

Reduce Power by up to 30%

A new feature called EcoView Optimizer 2 saves energy by up to 30% by reducing the backlight brightness and increasing the gain. To maintain image quality, EcoView Optimizer 2 only boosts the gain with a screen consisting mostly of dark content because the accompanying reduction in brightness is almost unperceivable.

Picture by Picture

The FlexScan EV2750 lets you view data from two input sources at once such as a Windows and a Macintosh computer with no distracting bezel in between.



Compliance with International Labels



Power Management Software

EIZO EcoView NET power management software helps organizations take advantage of the ergonomic and energy-saving features of EIZO monitors by allowing a network administrator to adjust their brightness and power settings from a central location. Please see www.eizoglobal.com for details.

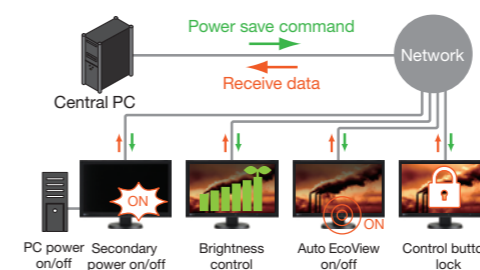

EIZO Monitor Configurator for Administrators

EIZO Monitor Configurator lets system administrators control the settings of all FlexScan EV monitors with a USB connection. The settings of one monitor can be saved as an xml file and can apply to other monitors via USB or office network.

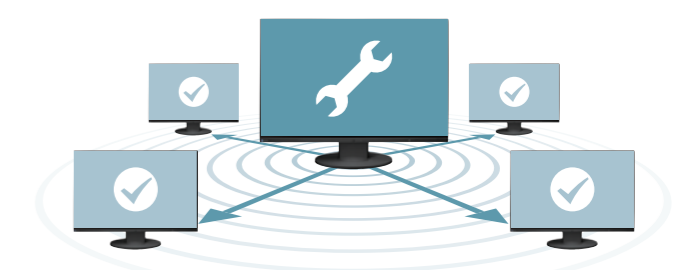

Eye pleasing, work achieving.

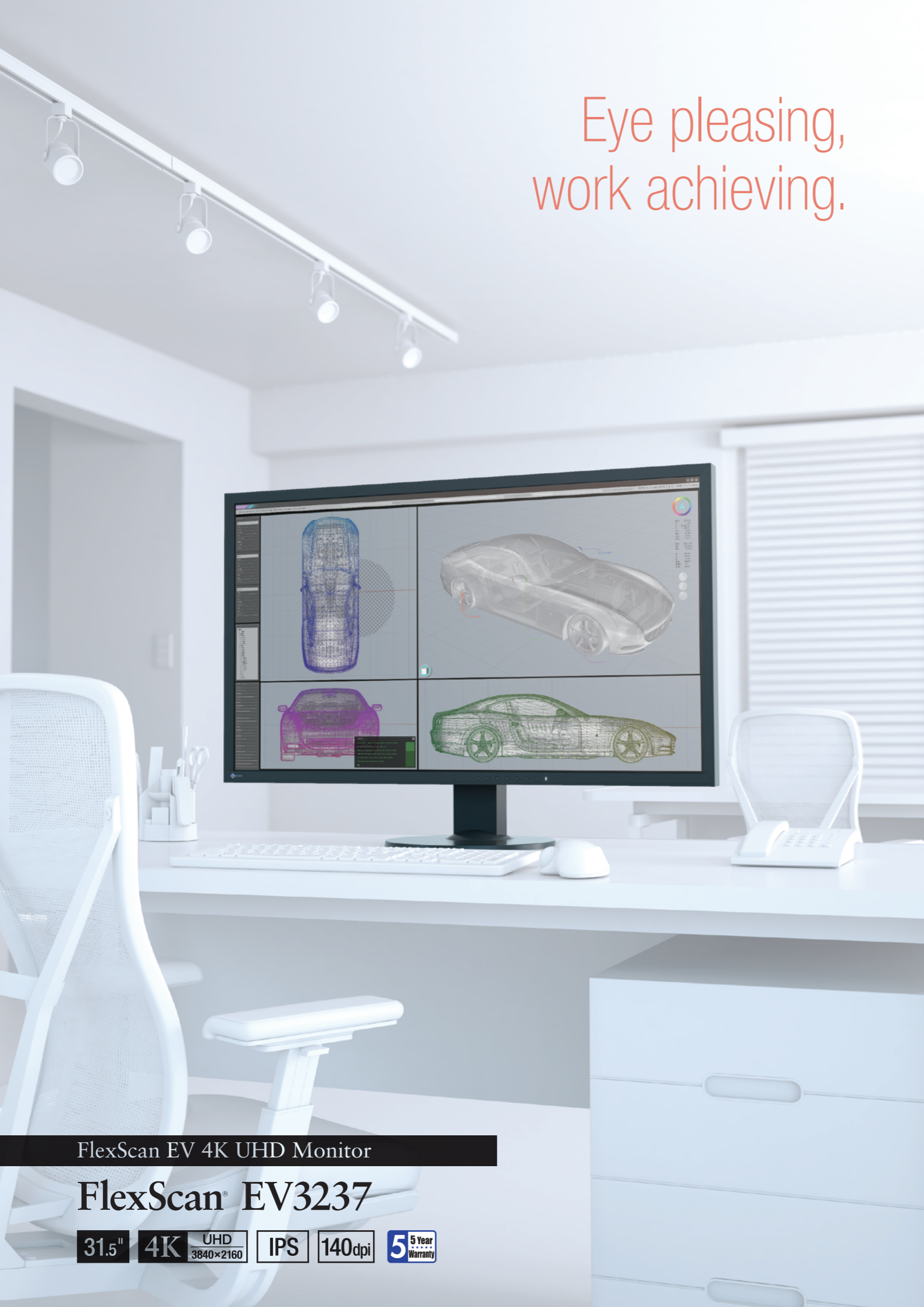

FlexScan EV 4K UHD Monitor

FlexScan® EV3237

31.5" 4K UHD 3840x2160 IPS 140dpi 5 Year Warranty

Why Choose EIZO 4K UHD?

The FlexScan EV3237, a 31.5-inch 4K IPS monitor with 3840 x 2160 native resolution, reproduces smooth images by taking an 8-bit signal (256 tones per RGB) and selecting the optimum color values from a 10-bit look-up table (1,021 tones). Whether you work on CAD, business, gaming or video – this 31.5-inch monitor does it all. It comes with all the ergonomic and economic features that the FlexScan EcoView Series offers as well as a 5-year warranty.

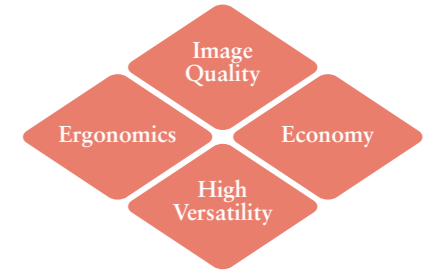

Convenient Multitasking with PbyP / PinP

Picture by Picture (PbyP) is a feature that allows you to view data from multiple signal sources on a single screen simultaneously. Picture in Picture (PinP) allows you to display a small separate screen from second signal source within the monitor. This allows you to effectively multitask such as viewing a video conference while working in other applications.



PbyP Patterns



Multiple Inputs

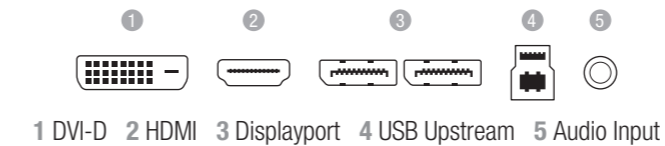

Audio and USB 3.0

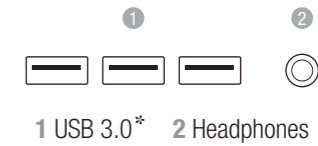

* One of the ports can be used as a USB 3.0 battery charger for your smartphone, tablet, or devices.

Ergonomics



5 Color Presets for Optimum Viewing
Lower Blue Light Reduces Eye Fatigue
Adjustable to Just 1% of Maximum Brightness
Auto Brightness Control

Clear View from All Angles



EV3237(IPS) Other(TN)

Flicker-Free Images



Ambient Light Sensor Presence Sensor

Significantly Reduce Power Consumption

The FlexScan EV3237 offers a number of features for lowering power consumption. The Auto EcoView brightness sensor automatically lowers brightness according to ambient lighting and EcoView Optimizer 2 reduces backlight brightness and increases gain when viewing dark content.

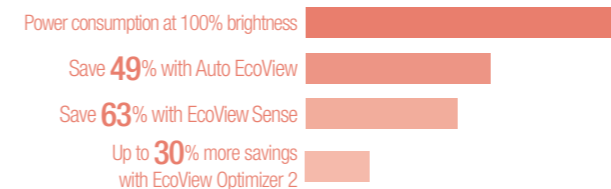

Presence Sensor for Energy Savings

A presence sensor called EcoView Sense prompts the monitor to switch to power save mode when you are absent and then power on again when you return. It even works in a multi-monitor setup so all monitors remain on when you're at your desk.



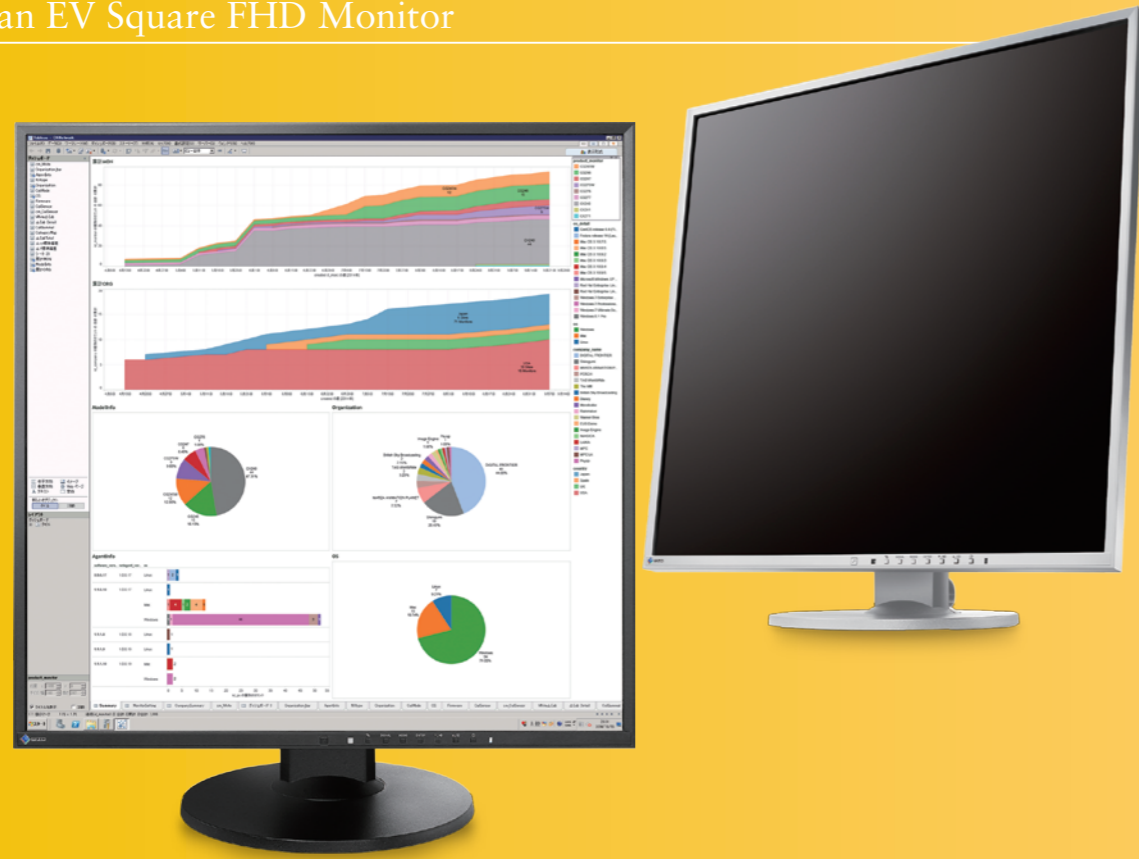

FlexScan® EV2730Q

26.5" SQFHD 1920×1920 IPS 5 Year Warranty

Desktop Screen Examples with SQFHD (1920×1920) Resolution

3D CAD

3D CAD designers can view more of their item lists with the extended vertical space. They can also use the entire screen to enlarge 3D objects and check vital details whereas a standard wide monitor leaves blank space around the object.

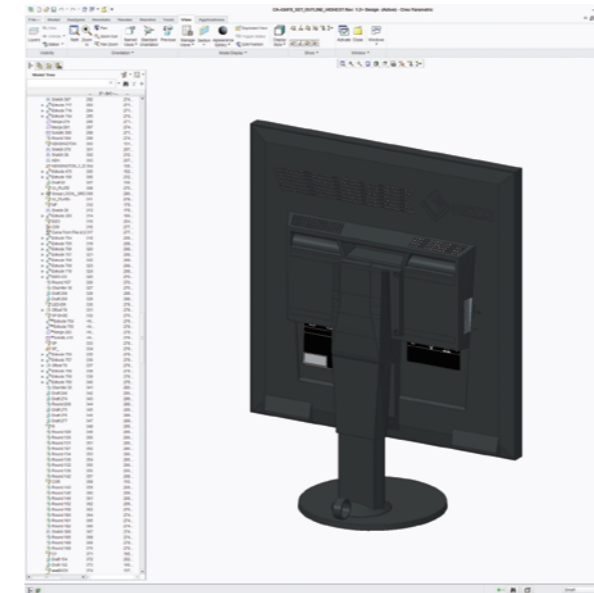

Program Development

With the extended vertical space, programmers can see all their work at once. This helps them work more efficiently and reduces the need for scrolling.

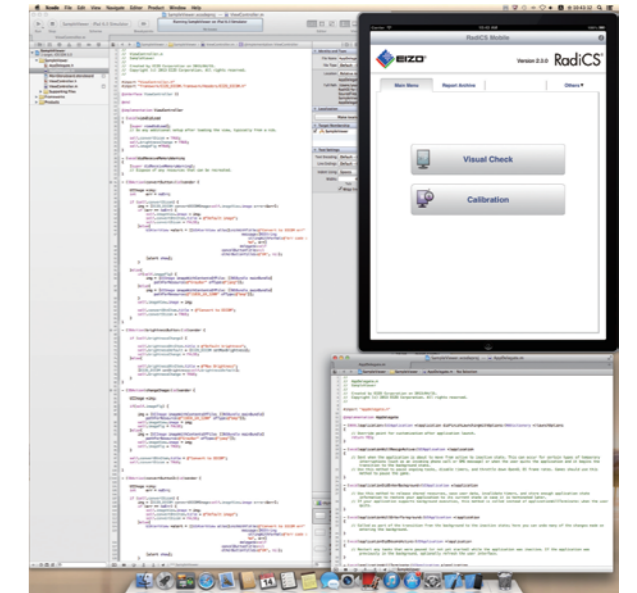

Unique SQFHD (1920×1920) Resolution for More Efficient Viewing of Data

Extended Vertical Space

78% more pixels compared to a Full HD monitor

The EV2730Q is wide all around. The unique 1920 × 1920 resolution provides users with 78% more pixels compared with a standard wide screen 1920 × 1080 monitor. The extended vertical space is convenient for displaying large amounts of information in long windows, reducing the need for scrolling and providing a more efficient view of data.



Other Examples with SQFHD (1920 x 1920) Resolution

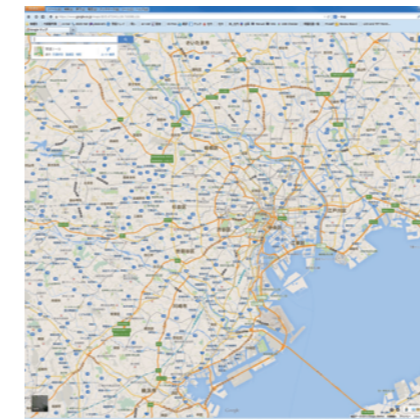

Map



Web Development

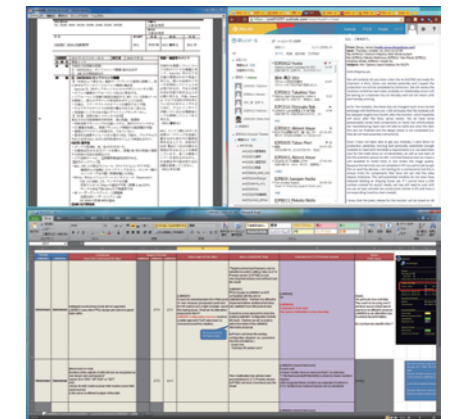

Spreadsheet



Full HD Video and Other Tasks

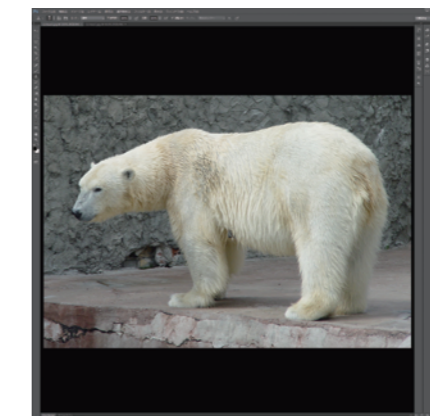

Photo (Landscape)



Photo (Portrait)



FlexScan®

EV2736W / EV2436W / EV2336W
EV2416W / EV2316W / EV2216W

27"	24"	23"	22"	5 Year Warranty
2560 × 1440	1920 × 1200	1920 × 1080	1680 × 1050	

Best Positioning with Flexible Stand

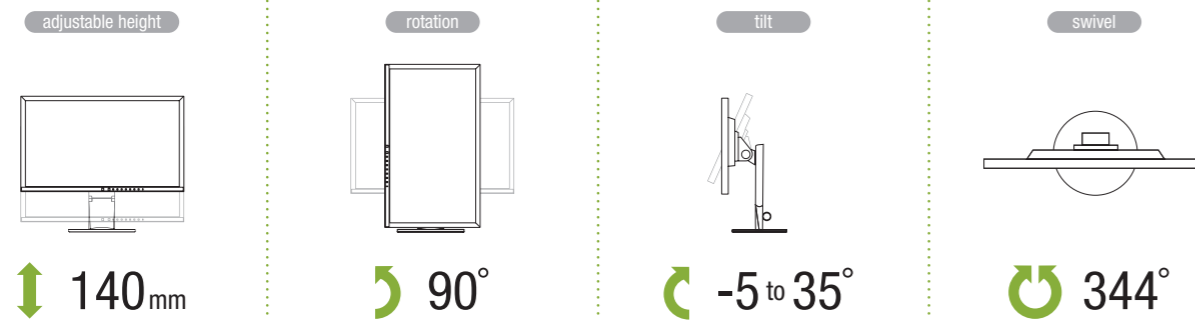

Carrying Handle

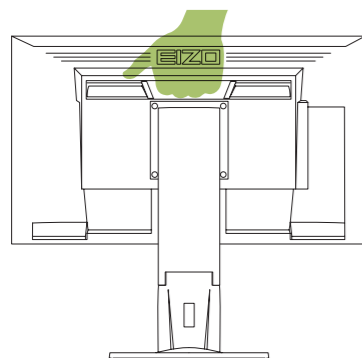

Cable Holder

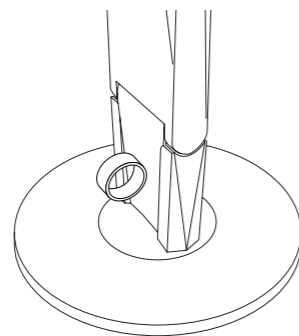

Multiple Inputs

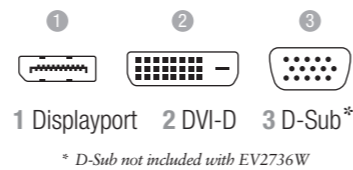

Audio and USB 2.0

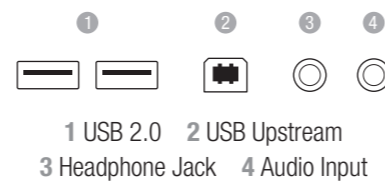

Flicker-Free Images

Due to the way brightness is controlled on LED backlights, a small number of people perceive flicker on their screen which causes eye fatigue. The FlexScan EV series utilizes a hybrid solution to regulate brightness and make flicker unperceivable without any drawbacks like compromising color stability.



Lower Blue Light Reduces Eye Fatigue

In the visible light spectrum, blue light has wave lengths adjacent to ultraviolet light. Compared to the factory preset setting of 6,500 K of typical LCD monitors, Paper Mode is closer to the spectral distribution with long reddish wavelengths so it reduces the amount of blue light, a cause of eye fatigue, and helps prevent eyestrain when reading documents.



Auto Brightness Control

To prevent eye fatigue, a brightness sensor called Auto EcoView detects the changes in the ambient brightness that occur throughout the day and automatically adjusts the screen to the ideal brightness level. Auto EcoView cuts power by almost 49% compared to operating the monitor at maximum brightness.

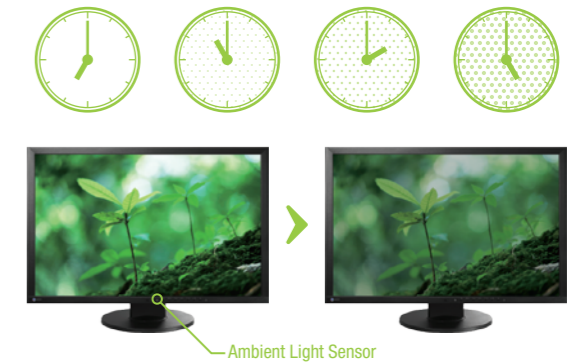

Adjustable to Less Than 1% of Maximum Brightness

In a dimly-lit work environment, a monitor with low brightness settings is more comfortable to use. With its LED backlight, the FlexScan EV Series is adjustable to 1 cd/m² which is less than 1% of the maximum.



Significantly Reduce Power Consumption

The FlexScan EV Series offers a number of features for lowering power consumption. The Auto EcoView brightness sensor automatically lowers brightness according to ambient lighting and EcoView Optimizer 2 reduces backlight brightness and increases gain when viewing dark content.

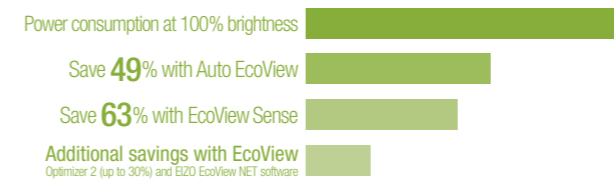

Presence Sensor for Energy Savings

A presence sensor called EcoView Sense prompts the monitor to switch to power save mode when you are absent and then power on again when you return. It even works in a multi-monitor setup so all monitors remain on when you're at your desk.



FlexScan Square Series

These versatile monitors are designed for back offices, trading floors, government facilities, CAD, and home use. They come in a square format and range in size from 15" to 21.3".

FlexScan®

S2133 / S1933 / S1923 / S1703 / S1503



Square Format

The FlexScan Square Series is ideal for environments where the traditional square format is required. These monitors come in 15", 17", 19", and 21.3" sizes with 5:4 or 4:3 aspect ratios.



Best Positioning

An ergonomic stand offers height adjustment, tilt, swivel, and portrait mode* so you can adjust the monitor to the most comfortable position for you.

*S1503 does not offer height adjustment or portrait mode display

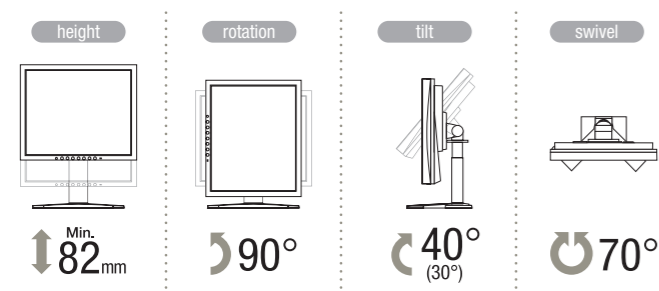

Unobstructive Speakers

0.5 watt speakers deliver audio capability and are built into the back of the cabinet where they are out of view and do not increase bezel size.



Speakers are hidden away in the back of the monitor to minimize bezel size.

*S2133 does not support audio

Support for Sync-on-Green

The FlexScan S1933, S1923, and S1703 can be used with legacy graphics boards that output a sync-on-green signal.

Digital and Analog Inputs

With both DVI and D-Sub mini 15-pin inputs, you can use a computer that has either a digital or an analog graphics board (or both if connected to two computers), and quickly switch between the inputs via a front panel button. The FlexScan S2133 is also equipped with a DisplayPort input.

Tireless Eyes

A brightly lit monitor can take a toll on your eyes. To prevent this, a brightness sensor called Auto EcoView detects the changes in the ambient brightness that occur throughout the day and automatically adjusts the screen to the ideal brightness level.

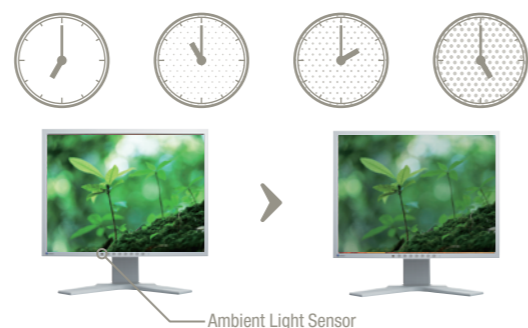

Preset Modes

For optimum viewing of different kinds of content, Paper mode, sRGB mode and Custom mode (user-defined settings) are included on most Square Series models with most models having additional presets. You can switch between modes manually with the press of a button or automatically with the bundled ScreenManager Pro for LCD software.

10-Bit Gamma Color

These monitors automatically take 8-bit input signals (256 tones for each primary color) from the graphics board and use a 10-bit look-up table (1,021 tones) to produce smoother more accurate gradations of color.

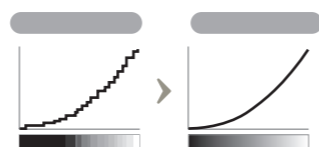

FlexScan Touch Series

The convenience of touch panel monitors makes them a practical choice for hospitals, factories, reception areas, and retail shops. Finger touch is standard, with pen touch available when using the optional touch pens.

FlexScan®

T2381W / T1781



Fully Flat Surface

The flat front glass enables seamless touch operation across the entire screen. The touch driver is compatible with Windows 8.1, 8, 7, and XP.

Multitouch Monitor

The FlexScan T2381W and T1781 support multitouch with projected capacitive technology. You can tap, drag, pinch, and spin etc with your fingers instead of a mouse and keyboard. The Windows 8 charm bar can also be easily accessed with a swipe motion.

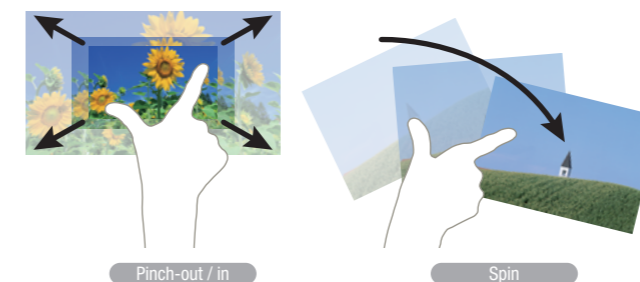

Wide Viewing Angles

FlexScan T2381W and T1781 use IPS (in-plane switching) LCD panels with wide viewing angles up to 178°. This ensures two people can comfortably view the screen while sitting side-by-side.



Multiple Inputs and USB 2.0

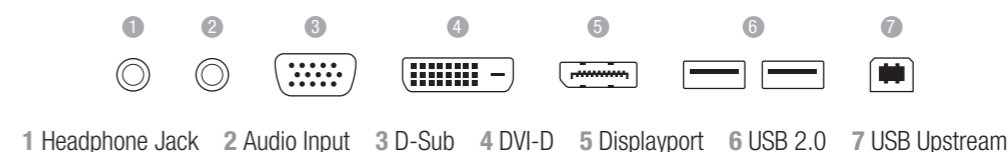

Flexible Stand for Ease of Use

The T2381W and T1781 come with stands that let you tilt the monitor back so you can look almost directly down at the screen as if you were reading a book and comfortably touch it with your elbows resting on the desktop. Most other models come with a height adjustable stand that also lets you tilt the screen back and forth and swivel it from side to side.

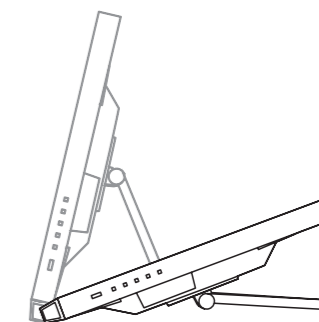

Detailed Color Control

Hue, gain, saturation, and color temperature in 500 K increments from 4,000 – 10,000 K (and 9,300 K) are all user adjustable. An sRGB mode is also included for color matching with other applications and peripherals that also support this color space.

Flicker-Free Images

Due to the way brightness is controlled on LED backlights, a small number of people perceive flicker on their screen which causes eye fatigue. The T2381W and T1781 relieves eye fatigue by regulating brightness to make flicker unperceivable.

Work better with FlexScan

Blue Light Reduction (Paper Mode + Auto EcoView)



Paper Mode Reduces Blue Light

Paper mode adjusts the brightness, contrast ratio, and color temperature of a monitor to resemble printed paper. Over the course of a work day PC users must constantly adjust to the difference between how monitors and paper appear. This overworks the muscles of the eyes and is thought to be a source of eye fatigue and stress. Paper mode was developed to alleviate the eye fatigue and stress that PC users feel. The combination of Paper Mode and the Auto EcoView brightness adjustment function reduces blue light even more. In a monitor with an LED backlight where Paper Mode and Auto EcoView were used, the blue light was measured and found to have only 32% the intensity of the factory setting.

Comparison between paper, monitor's factory settings, and Paper Mode

	Newspaper	Recycled Copy Paper	Monitor's Factory Settings	Paper Mode
Brightness	55% reflection rate, 88 cd/m ² *	70% reflection rate, 112 cd/m ² *	275 cd/m ² **	50 - 70% reflection rate
Contrast Ratio	6.2:1	10.7:1	1000:1**	About 30:1
Color Temperature	3,477 K	3,828 K	6500 K	4,000 - 5,000 K

* Measured at an ambient brightness of 500 lx.
** Average maximum brightness of EV2455 and EV2450.

Effect of Lowering Brightness and Color Temperature

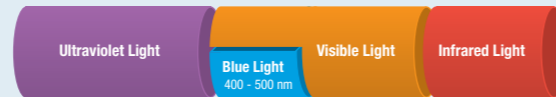
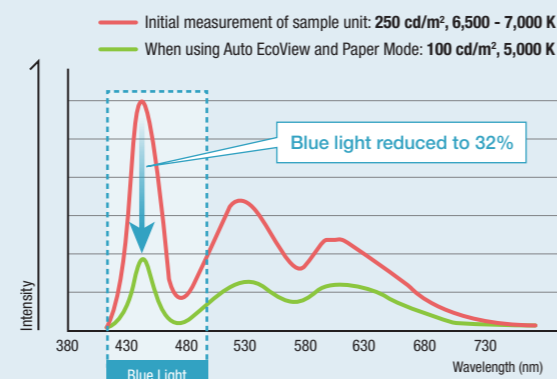

Color Temperature, Brightness and the Effect on Blue Light

In the visible light spectrum, blue light has wavelengths adjacent to ultraviolet light. Compared to the factory preset setting of 6,500 K of typical LCD monitors, Paper Mode is closer to the spectral distribution with long reddish wavelengths so it reduces the amount of blue light, a cause of eye fatigue.

Work Efficiency

Improved Work Efficiency, Reduced Visual Fatigue

EIZO conducted a survey to establish the relationship between eye fatigue and monitor use. The survey found that when you properly adjust your monitor's brightness, the reduction in your ability to focus drops by half (Graph 1). In addition, maintaining correct working posture and taking regular breaks further reduced fatigue levels and increased work efficiency by 12.5% (Graph 2).

Graph 1: Comparison between fatigue levels after monitor use

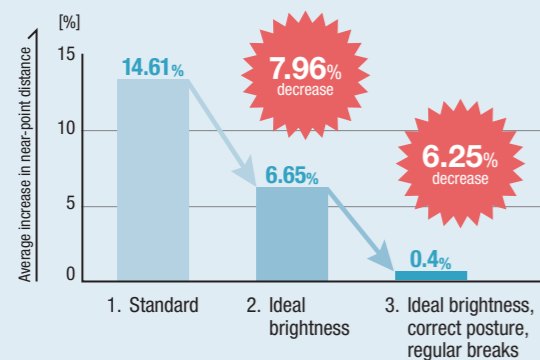

Graph 2: Quantity of VDT work per unit of time

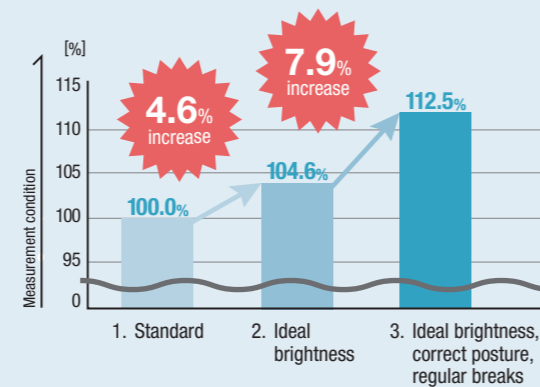

Dimming of LED Monitors

Many LCD monitors that use LED backlights employ "PWM dimming" to adjust the brightness by changing the length of the lighting and extinguishing time of the LED device. Since eye fatigue tends to result if the screen is too bright it is often used with a low luminance when viewing text for long periods of time.

Occurrence of Flicker

In PWM dimming, flickering of the LED device occurs at a high speed of about 200 Hz. But due to the suppression of illumination, the LED devices' blinking time shortens and flicker is easy to perceive. Even if flicker is unperceivable eye strain may occur before you know it.

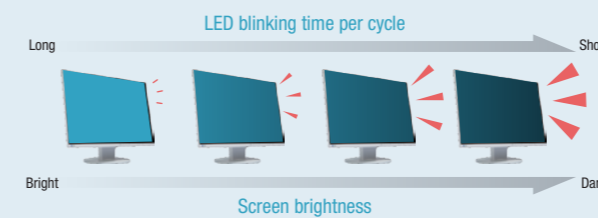

Flicker Reduction Technologies

EyeCare Dimming

- High brightness control: **DC dimming**
Reduces flicker and eye fatigue
- Low brightness control: **PWM dimming**
For low brightness when flicker is not noticeable. Maintains color reproducibility and stability.

Lower Total Cost of Ownership

Significantly Reduce Electricity Costs

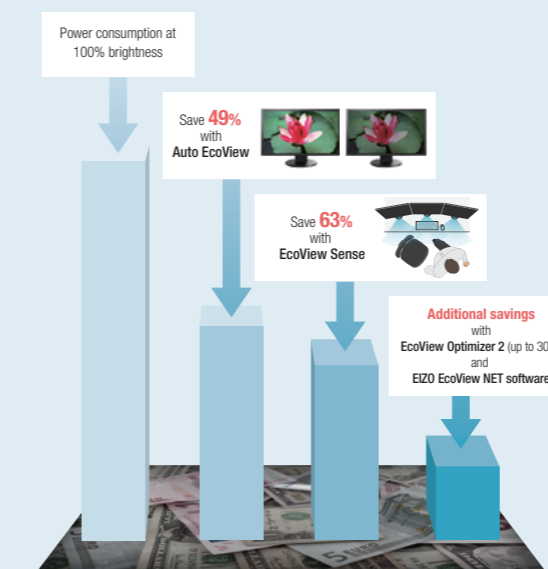

Dimmer range and flicker comparison

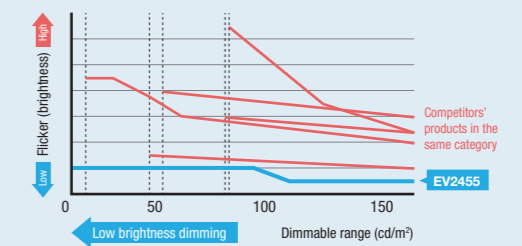

Comparison of FlexScan EV2450/EV2455 with competitors' products in the same category

Flicker reduced by 74% (EIZO survey)

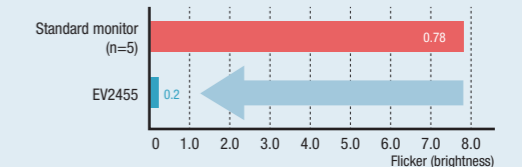

Dims at a lower brightness

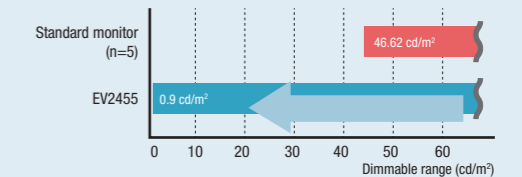

Calculate Your Potential Savings

Use our Eco Calculator to compare your monitor's electricity usage with that of an EIZO EcoView monitor.

<http://www.eizoglobal.com/i/ecocalculator/>



5 Year Warranty and Bright Pixel Policy

EIZO offers an industry-leading five-year warranty that covers all components including the LCD panel to ensure a long service life and low total cost of ownership. In addition, most EV monitors are warranted against bright sub-pixels for six months for units purchased on September 1, 2015 or later.



ACCESORIES

Wall Mount Arm

The LA-011-W is a single-axis arm with a minimum profile and tilt/swivel.

Supported Monitors: EV3237, EV2750, EV2736W, EV2730Q, EV2436W, S2133



Dual Height Adjustable Stand

Mount two monitors in either portrait or landscape orientation. Height is adjustable in six stages and cable housing in the back of the stand contributes to a clutter-free desktop.

Supported Monitors: S2133, S1933, S1923, S1703, S1503



Protection Panels

These panels protect against dust and scratches. They come in reversible glossy and non-glare sides.

Supported Monitors: All FlexScan EV Slim Series and S Series monitors



Screen Cleaner Kit

Keep your screen free from dust and fingerprints with this screen cleaner kit.

Includes pump spray and cloth.



Touch Panel Pointer

This dedicated touch pen is ideal for factory settings where the user is wearing gloves or with dense menus that are too small to touch with a finger.

Supported Monitors: T2381W, T1781



UTILITY SOFTWARE

ScreenManager Pro for Personal Settings

ScreenManager Pro lets users adjust color and EcoView settings with the mouse and keyboard instead of the on-screen display menu. It also offers multi-monitor matching which allows adjustments to be applied to all FlexScan monitors connected to a single PC.

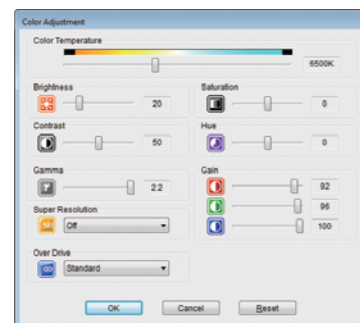

EIZO Screen Slicer

EIZO ScreenSlicer is a software utility that allows an entire screen to be effectively used through partitioning. Multiple windows can be easily aligned and dropped into the partitioned areas in single- or multimonitor environments.

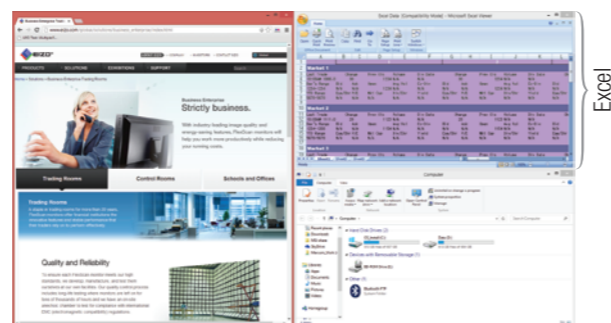

Browser

Explorer

Excel

	FlexScan EV3237	FlexScan EV2750	FlexScan EV2455	FlexScan EV2450
Cabinet Color	Gray, Black	White, Black	White, Gray, Black	White, Gray, Black
Panel	Type: IPS	Type: IPS	Type: IPS	Type: IPS
Backlight	LED	LED	LED	LED
Size	31.5" / 80 cm (799 mm diagonal)	27" / 68.5 cm	24.1" / 61 cm (611 mm diagonal)	23.8" / 60 cm (604 mm diagonal)
Native Resolution	DisplayPort: 3840 x 2160 (60Hz, 16:9 aspect ratio) DVI / HDMI: 3840 x 2160 (30Hz, 16:9 aspect ratio)	2560 x 1440 (16:9 aspect ratio)	1920 x 1200 (16:10 aspect ratio)	1920 x 1080 (16: 9 aspect ratio)
Display Size (H x V)	696.9 x 392.0 mm	596.7 x 335.7 mm	518.4 x 324.0 mm	527 x 296.4 mm
Pixel Pitch	0.1815 x 0.1815 mm	0.233 x 0.233 mm	0.270 x 0.270 mm	0.2745 x 0.2745 mm
Display Colors	16.77 million	16.77 million	16.77 million	16.77 million
Viewing Angles (H/V, typ.)	178°, 178°	178°, 178°	178°, 178°	178°, 178°
Brightness (typical)	300 cd/m ²	350 cd/m ²	300 cd/m ²	250 cd/m ²
Contrast Ratio (typical)	1000:1	1000:1	1000:1	1000:1
Response Time (typical)	5 ms (gray-to-gray)	5 ms (gray-to-gray)	5 ms (gray-to-gray)	5 ms (gray-to-gray)
Video Signals	Input Terminals DisplayPort 1.2 x 2 (with HDCP 1.x), DVI-D 24 pin x 1 (with HDCP 1.x), HDMI x1 (with HDCP 1.x)	DisplayPort x 1, DVI-D 24 pin x 1 (with HDCP), HDMI x1 (with HDCP)	D-Sub mini 15 pin x 1, DVI-D 24 pin x 1 (with HDCP), HDMI x 1 (with HDCP), DisplayPort x 1 (with HDCP)	D-Sub mini 15 pin x 1, DVI-D 24 pin x 1 (with HDCP), HDMI x 1 (with HDCP), DisplayPort x 1 (with HDCP)
	Digital (H, V) 31 - 134 kHz, 29 - 31 Hz and 59 - 61 Hz	31 - 89 kHz, 59 - 61 Hz	31 - 76 kHz, 59 - 61 Hz (VGA Text: 69 - 71 Hz)	31 - 68 kHz, 59 - 61 Hz (VGA Text: 69 - 71 Hz)
	Analog (H, V) -	-	31 - 81 kHz, 55 - 76 Hz	31 - 81 kHz, 55 - 76 Hz
	Sync Formats -	-	Separate	Separate
USB	Function 1 port for up stream 3-port USB hub (including 1 USB Battery charge port)	1 port for up stream 2-port USB hub	1 port for monitor control 2-port USB hub	1 port for monitor control 2-port USB hub
	Standard USB 3.0, USB BC 1.2	USB 3.0	USB 3.0	USB 3.0
Audio	Speakers 1.0 W +1.0 W	1.0 W +1.0 W	1.0 W +1.0 W	1.0 W +1.0 W
	Input Terminals 3.5 mm stereo jack	3.5 mm stereo jack	3.5 mm stereo jack	3.5 mm stereo jack
	Output Terminals 3.5 mm headphone jack	3.5 mm headphone jack	3.5 mm headphone jack	3.5 mm headphone jack
	Sound Adjustment Volume, Source (DisplayPort, HDMI)	Volume, Source (DisplayPort, HDMI)	Volume, Source (DisplayPort, HDMI)	Volume, Source (DisplayPort, HDMI)
Power	Power Requirements AC 100 - 120 V / 200 - 240 V, 50 / 60 Hz	AC 100 - 240 V, 50 / 60 Hz	AC 100 - 120 V / 200 - 240 V, 50 / 60 Hz	AC 100 - 120 V / 200 - 240 V, 50 / 60 Hz
	Max. Power Consumption 105 W	67 W	49 W	47 W
	Typ. Power Consumption 30 W	22 W	13 W	12 W
	Power Save Mode Less than 0.5 W	Less than 0.5 W	Less than 0.3 W	Less than 0.3 W
	Power Management Power Save (VESA DPM, DisplayPort Rev. 1.1a, and DVI DMPM), Eco Timer	Power Save (VESA DPM, DisplayPort Rev. 1.1a, and DVI DMPM), Eco Timer	Power Save (VESA DPM, DisplayPort Rev. 1.1a, and DVI DMPM), Eco Timer	Power Save (VESA DPM, DisplayPort Rev. 1.1a, and DVI DMPM), Eco Timer
Features & Functions	Preset Modes Color mode (Paper, Movie, sRGB, User1, User2, DICOM)	Color mode (Paper, Movie, sRGB, User1, User2, DICOM)	Color mode (Paper, Movie, sRGB, User1, User2, DICOM)	Color mode (Paper, Movie, sRGB, User1, User2, DICOM)
	Auto EcoView Yes	Yes	Yes	Yes
	EcoView Sense Yes	-	Yes	Yes
	OSD Languages English, French, German, Italian, Japanese, Simplified and Traditional Chinese, Spanish, Swedish	English, French, German, Italian, Japanese, Simplified and Traditional Chinese, Spanish, Swedish	English, French, German, Italian, Japanese, Simplified and Traditional Chinese, Spanish, Swedish	English, French, German, Italian, Japanese, Simplified and Traditional Chinese, Spanish, Swedish
Physical Specifications	Dimensions (W x H x D) 731 x 439 - 578 x 245 mm	611.6 x 390.2 - 545.2 x 245 mm	530.8 x 357.2 - 488.2 x 233 mm	537.6 x 333.5 - 473.5 x 233 mm
	Dimensions (Without Stand, W x H x D) 731 x 428 x 59.5 mm	611.6 x 359 x 48.5 mm	530.8 x 347.2 x 47.9 mm	537.6 x 317.6 x 47.9 mm
	Net Weight 10.6 kg	7.9 kg	6.5 kg	6.2 kg
	Net Weight (Without Stand) 7.8 kg	5.1 kg	4.1 kg	3.8 kg
	Height Adjustment Range 139 mm	155 mm	131 mm (maximum 140mm)	140 mm
	Tilt 35° Up, 5° Down	35° Up, 5° Down	35° Up, 5° Down	35° Up, 5° Down
	Swivel 344°	344°	344°	344°
	Pivot -	90°(both clockwise and counter clockwise)	90°(both clockwise and counter clockwise)	90°(both clockwise and counter clockwise)
	Hole Spacing (VESA Std.) 100 x 100 mm	100 x 100 mm	100 x 100 mm	100 x 100 mm
Certifications & Standards <small>(Please contact the EIZO group company or distributor in your country for the latest information.)</small>	TCO Displays 6.0, EPEAT Gold (US), TUV/Ergonomics, TUV/GS, RCM, CE, CB, cTUVus, FCC-B, Canadian ICES-003-B, TUV/S, VCCI-B, EPA Energy Star, RoHS, WEEE, China RoHS, CCC, EAC	TCO Displays 6.0, EPEAT Gold (US), TUV/Ergonomics, TUV/GS, RCM, CE, CB, cTUVus, FCC-B, Canadian ICES-003-B, TUV/S, VCCI-B, EPA Energy Star, RoHS, WEEE, China RoHS, CCC, EAC	TCO Displays 6.0, EPEAT Gold (US), TUV/Ergonomics, TUV/GS, RCM, CE, CB, cTUVus, FCC-B, Canadian ICES-003-B, TUV/S, VCCI-B, EPA Energy Star, RoHS, WEEE, China RoHS, CCC, EAC	TCO Displays 6.0, EPEAT Gold (US), TUV/Ergonomics, TUV/GS, RCM, CE, CB, cTUVus, FCC-B, Canadian ICES-003-B, TUV/S, VCCI-B, EPA Energy Star, RoHS, WEEE, China RoHS, CCC, EAC
Supplied Accessories <small>(May vary by country. Please contact EIZO for details.)</small>	AC power cord, signal cables (DisplayPort - DisplayPort), USB cable, EIZO LCD Utility Disk (PDF user's manual), setup guide	AC power cord, signal cables (DisplayPort - DisplayPort), USB cable, EIZO LCD Utility Disk (PDF user's manual), setup guide	AC power cord, signal cables (DisplayPort - DisplayPort), USB cable, EIZO LCD Utility Disk (PDF user's manual), setup guide	AC power cord, signal cables (DisplayPort - DisplayPort), USB cable, EIZO LCD Utility Disk (PDF user's manual), setup guide
Warranty	Five Years	Five Years	Five Years	Five Years
Zero Bright Pixels*	Yes	Yes	Yes	Yes

Dimension Diagrams (Unit:mm)

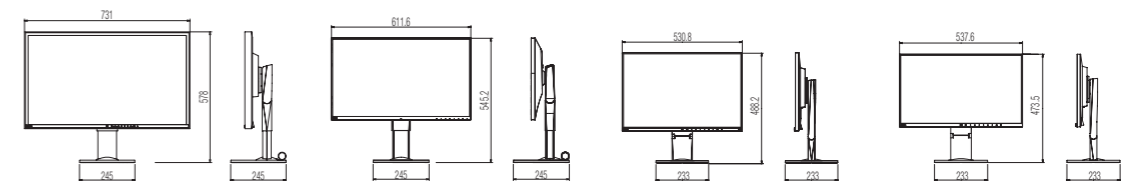

* 6 months from the date of purchase

Slim Monitors



	FlexScan EV2736W	FlexScan EV2436W	FlexScan EV2336W
Cabinet Color	Gray, Black	Gray, Black	Gray, Black
Panel	Type Backlight Size Native Resolution Display Size (H x V) Pixel Pitch Display Colors Viewing Angles (H / V, typ.) Brightness (typical) Contrast Ratio (typical) Response Time (typical)	IPS LED 24.1" / 61 cm (611 mm diagonal) 1920 x 1200 (16:10 aspect ratio) 518.4 x 324.0 mm 0.270 x 0.270 mm 16.77 million 178°, 178° 300 cd/m ² 1000:1 6 ms (gray-to-gray)	IPS LED 23" / 58 cm (584 mm diagonal) 1920 x 1080 (16:9 aspect ratio) 509.1 x 286.4 mm 0.2652 x 0.2652 mm 16.77 million 178°, 178° 300 cd/m ² 1000:1 6 ms (gray-to-gray)
Video Signals	Input Terminals Digital (H, V) Analog (H, V) Sync Formats	D-Sub mini 15 pin x 1, DVI-D 24 pin x 1 (with HDCP), DisplayPort x 1 (with HDCP) 31 – 89 kHz, 59 – 61 Hz (VGA Text: 69 – 71 Hz, WQHD SL: 29 – 31 Hz) 31 – 81 kHz, 55 – 76 Hz Separate	D-Sub mini 15 pin x 1, DVI-D 24 pin x 1 (with HDCP), DisplayPort x 1 (with HDCP) 31 – 68 kHz, 59 – 61 Hz (VGA Text: 69 – 71 Hz) 31 – 81 kHz, 55 – 76 Hz Separate
USB	Function Standard	1 port for monitor control 2-port USB hub USB 2.0	1 port for monitor control 2-port USB hub USB 2.0
Audio	Speakers Input Terminals Output Terminals Sound Adjustment	1.0 W +1.0 W 3.5 mm stereo jack 3.5 mm headphone jack Volume, Power Save, Source (DisplayPort)	1.0 W +1.0 W 3.5 mm stereo jack 3.5 mm headphone jack Volume, Power Save, Source (DisplayPort)
Power	Power Requirements Max. Power Consumption Typ. Power Consumption Power Save Mode Power Management	AC 100 – 120 V / 200 – 240 V, 50 / 60 Hz 67 W 24 W Less than 0.5 W Power Save (VESA DPM, DisplayPort Rev. 1.1a, and DVI DMPM), Eco Timer	AC 100 – 120 V / 200 – 240 V, 50 / 60 Hz 40 W 15 W Less than 0.3 W Power Save (VESA DPM, DisplayPort Rev. 1.1a, and DVI DMPM), Eco Timer
Features & Functions	Preset Modes Auto EcoView EcoView Sense OSD Languages	FineContrast (Paper, Movie, sRGB, User1, User2) Yes Yes English, German, French, Italian, Japanese, Simplified Chinese, Spanish, Swedish, Traditional Chinese	FineContrast (Paper, Movie, sRGB, User1, User2) Yes Yes English, French, German, Italian, Japanese, Simplified and Traditional Chinese, Spanish, Swedish
Physical Specifications	Dimensions (W x H x D) Dimensions (Without Stand, W x H x D) Net Weight Net Weight (Without Stand) Height Adjustment Range Tilt Swivel Pivot Hole Spacing (VESA Std.)	640 x 404.5 – 554.5 x 245 mm 640 x 379 x 65 mm 9.9 kg 7.3 kg 150 mm 35° Up, 5° Down 344° 90° 100 x 100 mm	552.5 x 368 – 499 x 233 mm 552.5 x 358 x 57 mm 6.4 kg 4.1 kg 131 mm (maximum 140 mm) 35° Up, 5° Down 344° 90° 100 x 100 mm
Certifications & Standards	TCO Displays 6.0, EPEAT Gold (US), TUV/Ergonomics, TUV/GS, RCM, CE, CB, cTUVus, FCC-B, Canadian ICES-003-B, TUV/S, VCCI-B, EPA Energy Star, RoHS, WEEE, China RoHS, CCC, EAC		
Supplied Accessories	AC power cord, signal cables (DVI-D – DVI-D (dual link supported)), DisplayPort – DisplayPort, EIZO LCD Utility Disk (PDF user's manual, ScreenManager Pro for LCD [DDC/CI], EIZO ScreenSlicer software), setup guide		
Warranty	Five Years		
Zero Bright Pixels*	Yes		

Dimension Diagrams (Unit:mm)

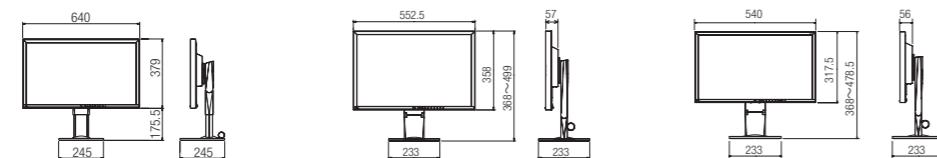

* 6 months from the date of purchase



	FlexScan EV2416W	FlexScan EV2316W	FlexScan EV2216W
Cabinet Color	Gray, Black	Gray, Black	Gray, Black
Panel	Type Backlight Size Native Resolution Display Size (H x V) Pixel Pitch Display Colors Viewing Angles (H / V, typ.) Brightness (typical) Contrast Ratio (typical) Response Time (typical)	TN LED 23" / 58 cm (584 mm diagonal) 1920 x 1080 (16:9 aspect ratio) 509.8 x 286.7 mm 0.270 x 0.270 mm 16.77 million 170°, 160° 250 cd/m ² 1000:1 5 ms (black-white-black)	TN LED 22" / 56 cm (558 mm diagonal) 1680 x 1050 (16:10 aspect ratio) 473.7 x 296.1 mm 0.282 x 0.282 mm 16.77 million 170°, 160° 250 cd/m ² 1000:1 5 ms (black-white-black)
Video Signals	Input Terminals Digital (H, V) Analog (H, V) Sync Formats	D-Sub mini 15 pin x 1, DVI-D 24 pin x 1 (with HDCP), DisplayPort x 1 (with HDCP) 31 – 76 kHz, 59 – 61 Hz 31 – 76 kHz, 55 – 61 Hz Separate	D-Sub mini 15 pin x 1, DVI-D 24 pin x 1 (with HDCP), DisplayPort x 1 (with HDCP) 31 – 67.5 kHz, 59 – 61 Hz DVI: 31 – 68.0 kHz, 59 – 61 Hz 31 – 68 kHz, 55 – 61 Hz Separate
USB	Function Standard	1 port for monitor control 2-port USB hub USB 2.0	1 port for monitor control 2-port USB hub USB 2.0
Audio	Speakers Input Terminals Output Terminals Sound Adjustment	1.0 W +1.0 W 3.5 mm stereo jack 3.5 mm headphone jack Volume, Power Save, Source (DisplayPort)	1.0 W +1.0 W 3.5 mm stereo jack 3.5 mm headphone jack Volume, Power Save, Source (DisplayPort)
Power	Power Requirements Max. Power Consumption Typ. Power Consumption Power Save Mode Power Management	AC 100 – 120 V / 200 – 240 V, 50 / 60 Hz 45 W 15 W Less than 0.3 W Power Save (VESA DPM, DisplayPort Rev. 1.1a, and DVI DMPM), Eco Timer	AC 100 – 120 V / 200 – 240 V, 50 / 60 Hz 39 W 12 W Less than 0.3 W Power Save (VESA DPM, and DVI DMPM), Eco Timer
Features & Functions	Preset Modes Auto EcoView EcoView Sense OSD Languages	FineContrast (Paper, Movie, sRGB, User1, User2) Yes Yes English, French, German, Italian, Japanese, Simplified and Traditional Chinese, Spanish, Swedish	FineContrast (Paper, Movie, sRGB, User1, User2) Yes Yes English, French, German, Italian, Japanese, Simplified and Traditional Chinese, Spanish, Swedish
Physical Specifications	Dimensions (W x H x D) Dimensions (Without Stand, W x H x D) Net Weight Net Weight (Without Stand) Height Adjustment Range Tilt Swivel Pivot Hole Spacing (VESA Std.)	552.5 x 368 – 499 x 233 mm 552.5 x 358 x 57 mm 6.1 kg 3.7 kg 131 mm (maximum 140 mm) 35° Up, 5° Down 344° 90° 100 x 100 mm	540 x 368 – 478.5 x 233 mm 540 x 317.5 x 56 mm 5.4 kg 3.1 kg 140 mm 35° Up, 5° Down 344° 90° 100 x 100 mm
Certifications & Standards	TCO Displays 6.0, EPEAT Gold (US), TUV/Ergonomics, TUV/GS, RCM, CE, CB, cTUVus, FCC-B, Canadian ICES-003-B, TUV/S, VCCI-B, EPA Energy Star, RoHS, WEEE, China RoHS, CCC, EAC		
Supplied Accessories	AC power cord, signal cables (DVI-D – DVI-D, DisplayPort – DisplayPort), EIZO LCD Utility Disk (PDF user's manual, ScreenManager Pro for LCD [DDC/CI], EIZO ScreenSlicer software), setup guide		
Warranty	Five Years		
Zero Bright Pixels*	-		

Dimension Diagrams (Unit:mm)

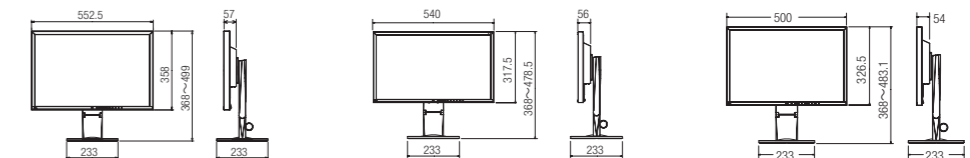

* 6 months from the date of purchase

SQFHD Monitor Square Series



		FlexScan EV2730Q	FlexScan S2133	FlexScan S1933	FlexScan S1923	
Model Variations		With FlexStand, Without Stand	With Height Adjustable Stand, Without Stand	With Height Adjustable Stand, With Tilt Stand, Without Stand	With Height Adjustable Stand, Without Stand	
Cabinet Color		Gray, Black	Gray, Black	Gray, Black	Gray, Black	
Panel	Type	IPS	IPS	IPS	VA	
	Backlight	LED	LED	LED	LED	
	Size	26.5" / 67 cm (672 mm diagonal)	21.3" / 54 cm (540 mm diagonal)	19" / 48 cm (481 mm diagonal)	19" / 48 cm (481 mm diagonal)	
	Native Resolution	1920 x 1920 (1:1 aspect ratio)	1600 x 1200 (4:3 aspect ratio)	1280 x 1024 (5:4 aspect ratio)	1280 x 1024 (5:4 aspect ratio)	
	Display Size (H x V)	475.7 x 475.7 mm	432 x 324 mm	376.3 x 301.0 mm	376.3 x 301 mm	
	Pixel Pitch	0.2478 x 0.2478 mm	0.270 x 0.270 mm	0.294 x 0.294 mm	0.294 x 0.294 mm	
	Display Colors	16.77 million	16.77 million from a palette of 1.06 billion	16.77 million from a palette of 1.06 billion	16.77 million from a palette of 1.06 billion	
	Viewing Angles (H / V, typ.)	178°, 178°	178°, 178°	178°, 178°	178°, 178°	
	Brightness (typical)	300 cd/m ²	420 cd/m ²	250 cd/m ²	250 cd/m ²	
	Contrast Ratio (typical)	1000:1	1500:1	1000:1	2000:1	
Response Time (typical)	5 ms (gray-to-gray)	6 ms (gray-to-gray)	14 ms (gray-to-gray)	20 ms (black-white-black)		
Touch Panel	Type	-	-	-	-	
	Communication Protocol	-	-	-	-	
	Touch Life	-	-	-	-	
	Surface Hardness	-	-	-	-	
	Compatible OS	-	-	-	-	
Video Signals	Input Terminals	DisplayPort x 1, DVI-D 24 pin x 1 (with HDCP)	D-Sub mini 15 pin x 1, DVI-D 24 pin x 1 (with HDCP), DisplayPort x 1 (with HDCP)	D-Sub mini 15 pin, DVI-D 24 pin (with HDCP)	D-Sub mini 15 pin, DVI-D 24 pin (with HDCP)	
	Digital (H / V)	31 - 127 kHz, 59 - 61 Hz (VGA Text: 69 - 71 Hz, Single link: 29 - 31 Hz)	31 - 76 kHz, 59 - 61 Hz (VGA Text: 69 - 71 Hz)	31 - 64 kHz, 59 - 61 Hz (VGA Text: 69 - 71 Hz)	31 - 64 kHz, 59 - 61 Hz (VGA Text: 69 - 71 Hz)	
	Analog (H / V)	-	24 - 80 kHz, 49 - 76 Hz	31 - 80 kHz, 50 - 75 Hz	31 - 80 kHz, 50 - 75 Hz	
	Sync Formats	-	Separate, Composite	Separate, Sync on green	Separate, Sync on green	
USB	Function	1 port for up stream 2-port USB hub	1 port for monitor control 2-port USB hub	-	-	
	Standard	USB 2.0	USB 2.0	-	-	
Audio	Speakers	1.0 W + 1.0 W	-	0.5 W + 0.5 W	0.5 W + 0.5 W	
	Input Terminals	3.5 mm stereo jack	-	3.5 mm stereo jack	3.5 mm stereo jack	
	Output Terminals	3.5 mm headphone jack	-	3.5 mm headphone jack	3.5 mm headphone jack	
	Sound Adjustment	Volume, Power Save, Source (DisplayPort)	-	Volume	Volume	
	Power Requirements	AC 100 - 240 V, 50 / 60 Hz	AC 100 - 120 V / 200 - 240 V, 50 / 60 Hz	AC 100 - 120 V / 200 - 240 V, 50 / 60 Hz	AC 100 - 120 V / 200 - 240 V, 50 / 60 Hz	
Power	Max. Power Consumption	64 W	45 W	24 W	41 W	
	Typ. Power Consumption	25 W	13 W	12 W	16 W	
	Power Save Mode	Less than 0.5 W	Less than 0.3 W	Less than 0.5 W	Less than 0.5 W	
	Standby Mode	-	-	-	-	
	Power Management	Power Save (VESA DPM, DisplayPort Rev. 1.1a, and DVI DMPM), Eco Timer	Power Save (VESA DPM and DVI DMPM), Eco Timer	Power Save (VESA DPM and DVI DMPM), Eco Timer	Power Save (VESA DPM and DVI DMPM), Eco Timer	
Features & Functions	Preset Modes	FineContrast (Paper, Movie, sRGB, User1, User2)	FineContrast (Paper, Movie, sRGB, User1, User2, DICOM)	FineContrast (Text, sRGB, EyeCare, Paper, Custom, DICOM)	FineContrast (Text, sRGB, EyeCare, Paper, Custom)	
	Auto EcoView	Yes	Yes	Yes	Yes	
	OSD Languages	English, French, German, Italian, Japanese, Simplified and Traditional Chinese, Spanish, Swedish	English, French, German, Italian, Japanese, Simplified and Traditional Chinese, Spanish, Swedish	English, French, German, Italian, Japanese, Simplified and Traditional Chinese, Spanish, Swedish	English, French, German, Italian, Japanese, Simplified and Traditional Chinese, Spanish, Swedish	
	Physical Specifications					
Physical Specifications	Dimensions (W x H x D)	497 x 512.5 - 613.5 x 245 mm	465 x 453 - 535 x 208.5 mm	With Height Adjustable Stand: 405 x 406.5 - 506.5 x 205 mm With Tilt Stand: 405 x 416 x 205 mm	405 x 406.5 - 506.5 x 205 mm	
	Dimensions (Without Stand, W x H x D)	497 x 501.5 x 56 mm	465 x 361 x 64 mm	405 x 334 x 61.5 mm	405 x 334 x 61.5 mm	
	Net Weight	7.1 kg	8.6 kg	With Height Adjustable Stand: 5.9 kg With Tilt Stand: 4.9 kg	6.0 kg	
	Net Weight (Without Stand)	4.2 kg	5.6 kg	4.1 kg	4.2 kg	
	Height Adjustment Range	101 mm (maximum 141 mm)	82 mm	With Height Adjustable Stand: 100 mm With Tilt Stand: -	100 mm	
	Tilt	35° Up, 5° Down	40° Up, 0° Down	With Height Adjustable Stand: 30° Up, 0° Down With Tilt Stand: 30° Up, 5° Down	30° Up, 0° Down	
	Swivel	344°	35° Right / 35° Left	With Height Adjustable Stand: 35° Right / 35° Left With Tilt Stand: -	35° Right / 35° Left	
Pivot	-	90°	With Height Adjustable Stand: 90° With Tilt Stand: -	90°		
Hole Spacing (VESA Std.)	100 x 100 mm	100 x 100 mm	100 x 100 mm	100 x 100 mm		
Certifications & Standards	TCO Displays 6.0, EPEAT Gold (US), TÜV/Ergonomics, TÜV/GS, RCM, CE, CB, cTUVus, FCC-B, Canadian ICES-003-B, TÜV/S, VCCI-B, EPA Energy Star, RoHS, WEEE, China RoHS, CCC, EAC					
Supplied Accessories	AC power cord, signal cables (DVI-D - DVI-D (dual link supported)), DisplayPort - DisplayPort, EIZO LCD Utility Disk (PDF user's manual, ScreenManager Pro for LCD (DDC/C), EIZO ScreenSlicer software), setup guide					
Warranty	Five Years		Five Years		Five Years	
Zero Bright Pixels*	Yes		-		-	

Dimension Diagrams (Unit:mm)

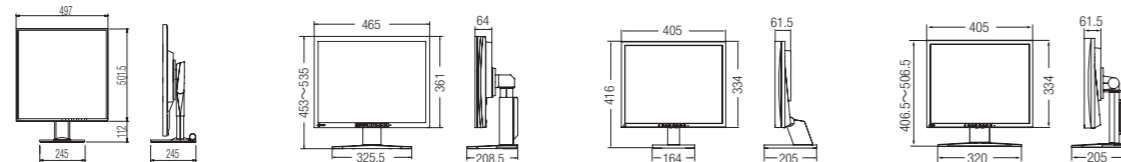

* 6 months from the date of purchase

SPECIFICATIONS

Touch Series

		FlexScan S1703	FlexScan S1503	FlexScan T2381W	FlexScan T1781	
Model Variations		With Height Adjustable Stand, With Tilt Stand, Without Stand	-	-	-	
Cabinet Color		Gray, Black	Gray, Black	Gray, Black	Gray, Black	
Panel	Type	TN	TN	IPS	IPS	
	Backlight	LED	LED	LED	LED	
	Size	17" / 43 cm (432 mm diagonal)	15" / 38 cm (380 mm diagonal)	23" / 58 cm (584 mm diagonal)	17" / 43 cm (432 mm diagonal)	
	Native Resolution	1280 x 1024 (5:4 aspect ratio)	1024 x 768 (4:3 aspect ratio)	1280 x 1024 (5:4 aspect ratio)	1280 x 1024 (5:4 aspect ratio)	
	Display Size (H x V)	337.92 x 270.336 mm	304.1 x 228 mm	509.1 x 286.4 mm	337.9 x 270.3 mm	
	Pixel Pitch	0.264 x 0.264 mm	0.297 x 0.297 mm	0.265 x 0.265 mm	0.264 x 0.264 mm	
	Display Colors	16.77 million from a palette of 1.06 billion	16.77 million from a palette of 1.06 billion	16.77 million from a palette of 1.06 billion	16.77 million from a palette of 1.06 billion	
	Viewing Angles (H / V, typ.)	170°, 160°	160°, 160°	178°, 178°	178°, 178°	
	Brightness (typical)	250 cd/m ²	400 cd/m ²	260 cd/m ²	350 cd/m ²	
	Contrast Ratio (typical)	1000:1	2000:1	600:1	1000:1	
Response Time (typical)	5 ms (black-white-black)	8 ms (black-white-black)	6 ms (gray-to-gray)	22 ms (black-white-black)		
Touch Panel	Type	-	-	Project Capacitive	Project Capacitive	
	Communication Protocol	-	-	USB	USB	
	Touch Life	-	-	50 million touches (minimum)	50 million touches (minimum)	
	Surface Hardness	-	-	5H	5H	
	Compatible OS	-	-	Multi-touch: Windows 8.1 (32-bit, 64-bit) / Windows 8 (32-bit, 64-bit) / Windows 7 (32-bit, 64-bit); Single-touch: Windows XP (32-bit)	Multi-touch: Windows 8.1 (64-bit, 32-bit) / Windows 8 (64-bit, 32-bit) / Windows 7 (32-bit, 64-bit) / Windows XP (32-bit)	
Video Signals	Input Terminals	D-Sub mini 15 pin, DVI-D 24 pin (with HDCP)	D-Sub mini 15 pin x 1, DVI-D 24 pin x 1 (with HDCP)	D-Sub mini 15 pin x 1, DVI-D 24 pin x 1 (with HDCP), DisplayPort x 1 (with HDCP)	D-Sub mini 15 pin x 1, DVI-D 24 pin x 1 (with HDCP), DisplayPort x 1 (with HDCP)	
	Digital (H / V)	31 - 64 kHz, 59 - 61 Hz (VGA Text: 69 - 71 Hz)	31 - 49 Hz, 59 - 61 Hz (VGA Text: 69 - 71 Hz)	31 - 68 kHz, 59 - 61 Hz (VGA Text: 69 - 71 Hz)	31 - 64 kHz, 59 - 61 Hz (VGA Text: 69 - 71 Hz)	
	Analog (H / V)	31 - 80 kHz, 50 - 75 Hz	24.8 - 60.5 kHz, 55 - 75.5 kHz	31 - 81 kHz, 55 - 76 Hz	31 - 81 kHz, 50 - 76 Hz	
	Sync Formats	Separate, Sync on green	Separate	Separate	Separate	
USB	Function	-	-	1 port for touch panel control 2-port USB hub	1 port for touch panel control 2-port USB hub	
	Standard	-	-	USB 2.0	USB 2.0	
Audio	Speakers	0.5 W + 0.5 W	0.5 W + 0.5 W	1.0 W + 1.0 W	1.0 W + 1.0 W	
	Input Terminals	3.5 mm stereo jack	3.5 mm stereo jack	3.5 mm stereo jack	3.5 mm stereo jack	
	Output Terminals	3.5 mm headphone jack	3.5 mm headphone jack	3.5 mm headphone jack	3.5 mm headphone jack	
	Sound Adjustment	Volume	Volume	Volume, Power Save, Source (DisplayPort)	Volume, Power Save, Source (DisplayPort)	
	Power Requirements	AC 100 - 120 V / 200 - 240 V, 50 / 60 Hz	AC 100 - 120 V / 200 - 240 V, 50 / 60 Hz	AC 100 - 120 V / 200 - 240 V, 50 / 60 Hz	AC 100 - 120 V / 200 - 240 V, 50 / 60 Hz	
Power	Max. Power Consumption	25 W	16 W	56 W	39 W	
	Typ. Power Consumption	9 W	6 W	18 W	11 W	
	Power Save Mode	Less than 0.5 W	Less than 1 W	Less than 0.5 W	Less than 0.5 W	
	Standby Mode	-	-	Less than 0.5 W	Less than 0.5 W	
	Power Management	Power Save (VESA DPM and DVI DMPM), Eco Timer	Power Save (VESA DPM), Eco Timer	Power Save (VESA DPM, DisplayPort Rev. 1.1a, and DVI DMPM), Eco Timer	Power Save (VESA DPM, DisplayPort Rev. 1.1a, and DVI DMPM), Eco Timer	
Features & Functions	Preset Modes	FineContrast (Text, sRGB, EyeCare, Paper, Custom)	EyeCare, Text, sRGB, Custom	FineContrast (Paper, Movie, sRGB, User1, User2)	FineContrast (Paper, Movie, sRGB, User1, User2)	
	Auto EcoView	Yes	Yes	-	-	
	OSD Languages	English, French, German, Italian, Japanese, Simplified and Traditional Chinese, Spanish, Swedish	English, French, German, Italian, Japanese, Simplified and Traditional Chinese, Spanish, Swedish	English, French, German, Italian, Japanese, Simplified and Traditional Chinese, Spanish, Swedish	English, French, German, Italian, Japanese, Simplified and Traditional Chinese, Spanish, Swedish	
	Physical Specifications					
Physical Specifications	Dimensions (W x H x D)	With Height Adjustable Stand: 367 x 391.5 - 491.5 x 205 mm With Tilt Stand: 367 x 384 x 188 mm	346 x 349 x 157 mm	556.7 x 143.9 - 360.7 x 89 - 401.3 mm	392 x 142.5 - 356 x 89 - 400.5 mm	
	Dimensions (Without Stand, W x H x D)	367 x 304 x 59 mm	346 x 280 x 69 mm	556.7 x 339.2 x 54 mm	392 x 331 x 54 mm	
	Net Weight	With Height Adjustable Stand: 5.5 kg With Tilt Stand: 4.4 kg	4.7 kg	6.6 kg	4.8 kg	
	Net Weight (Without Stand)	3.6 kg	3.4 kg	6.0 kg	4.3 kg	
	Height Adjustment Range	With Height Adjustable Stand: 100 mm With Tilt Stand: -	-	-	-	
	Tilt	With Height Adjustable Stand: 30° Up, 0° Down With Tilt Stand: 30° Up, 5° Down	30° Up, 0° Down	15° - 70°	15° - 70°	
	Swivel	With Height Adjustable Stand: 35° Right / 35° Left With Tilt Stand: -	-	-	-	
Pivot	With Height Adjustable Stand: 90° With Tilt Stand: -	-	-	-		
Hole Spacing (VESA Std.)	100 x 100 mm	100 x 100 mm	100 x 100 mm	100 x 100 mm		
Certifications & Standards	TCO Displays 6.0, EPEAT Gold (US), TÜV/Ergonomics, TÜV/GS, CE, CB, cTUVus, FCC-B, Canadian ICES-003-B, TÜV/S, VCCI-B, EPA Energy Star, RoHS, WEEE, China RoHS, CCC					
Supplied Accessories	AC power cord, signal cables (D-Sub - D-Sub, DVI-D - DVI-D), audio cable, setup guide, CD-ROM (PDF user's manual, ScreenManager Pro for LCD (DDC/C), EIZO ScreenSlicer software), 4 screws for mount option, warranty card					
Warranty	Five Years		Five Years		Three Years	
Zero Bright Pixels*	-		-		-	

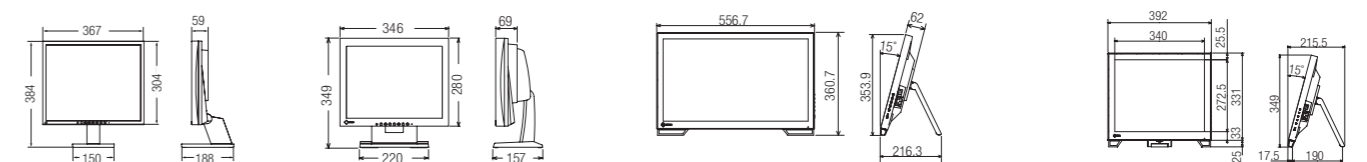

SPECIFICATIONS